



## **aero<sup>2</sup> ACTUATOR - INSTALLATION, OPERATION & MAINTENANCE MANUAL**

### **IMPORTANT SAFETY WARNINGS**

- A. Before carrying out any repair or maintenance on the actuator, make sure that the pressure supply lines and electrical connections have been safely isolated, removed or disconnected by authorized personnel. The actuator must not be pressurized at any time during installation as injury may result.
- B. Never put any part of your body in the opening or port of the controlled valve or device.
- C. Special attention and precautions should be observed of the stored energy contained in the spring return pneumatic actuators. Do not disassemble individual spring cartridges. Disassembly may result in personal injury.
- D. Before installing onto a valve make sure that the rotation of the valve and the actuator are the same and that the position indicator orientation is also correct.
- E. For correct operation, a pneumatic actuator must be sized adequately and with sufficient safety margin of torque output for the correct operating conditions of the valve.

\*Authorized and skilled personnel should only perform maintenance of these actuators.

### **GENERAL**

This instruction manual contains important information regarding the installation, operation, maintenance and storage for rack and pinion pneumatic actuators. Please read these instructions carefully and save them for future reference. It is important that only properly trained personnel disassemble or assemble the actuator.

### **DESCRIPTION OF *aero<sup>2</sup>* ACTUATORS**

The Aluminum pneumatic actuator is a 90° Double acting or Spring return rack and pinion system, which has been designed for the actuation of all type of 1/4 turn valves or 1/4 turn applications. The special finish of the interior surface of the body (Ra 0.4 – 0.6 µm) together with the use of antifriction pads manufactured in material of a very low coefficient of friction, mounted in the pistons, prevent metal on metal contact. SVF Flow Controls, Inc. actuators enjoy a long and maintenance free life.

### **Operating Media**

- Clean, dry and lubricated compressed air
- Light hydraulic oil
- Natural gas
- Any other Inert and non corrosive gas (consult SVF)

The maximum particle size must not exceed 0.001 µin (30 µm)

### **Supply Pressure**

- Minimum: 15 psig (1 bar)
- Maximum: 120 psig (8 bar)

### **Operating Temperature**

- Standard (Buna “N”): -4°F~ 176°F (-20°C~+80°C)
- High temperature (Viton O-ring): +5°F~+302°F (-15°C~+150°C)

NOTE: Caution: For low and high temperature service, special grease is required.

High and low temperature will vary the output torque of the actuator.

# aero<sup>2</sup> ACTUATOR - INSTALLATION, OPERATION & MAINTENANCE MANUAL

## LUBRICATION

The actuator is supplied ready-lubricated no further lubrication is required.

- Do not operate the actuator by using flammable, oxidizing, corrosive, explosive or instable gases.
- Operating the actuator beyond its stated maximum operating limits of temperature, pressure or recommend operating media, can cause personal safety risks, including death or injury, and/or damage to internal components and to actuator housing.

## PRINCIPLE OF OPERATION

### Double acting actuator

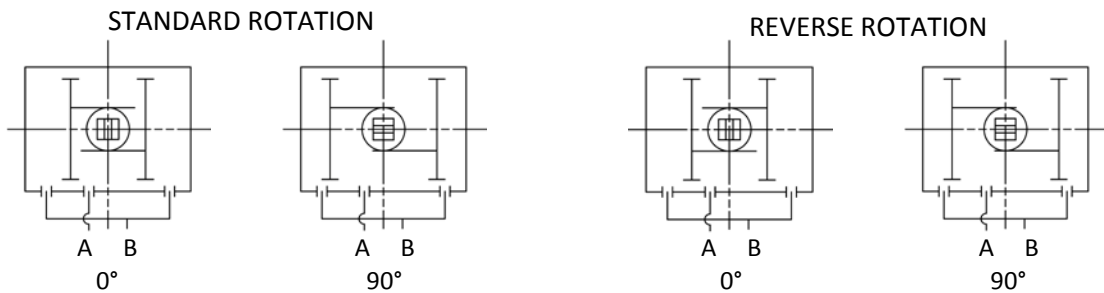

### STANDARD ROTATION:

Air to port A forces the pistons outwards, causing the pinion to turn counterclockwise while the air is being exhausted from port B. Air to port B forces the pistons inwards, causing the pinion to turn clockwise while the air is being exhausted from port A.

### REVERSE ROTATION:

Air to port A forces the pistons outwards, causing the pinion to turn clockwise while the air is being exhausted from port B. Air to port B forces the pistons inwards, causing the pinion to turn counterclockwise while the air is being exhausted from port A.

### Spring return actuator

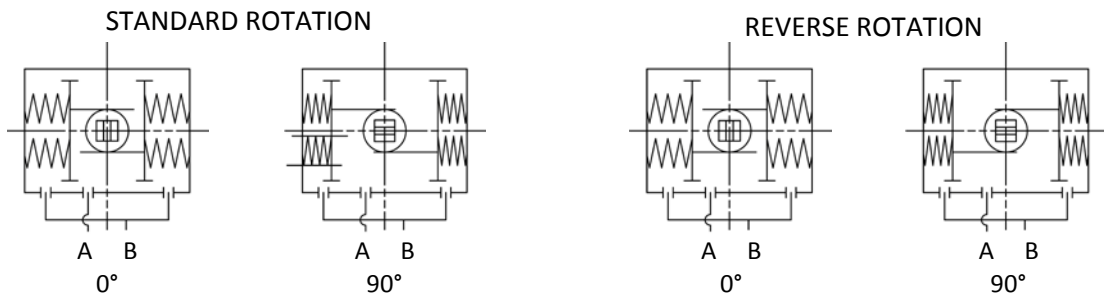

**aero<sup>2</sup> ACTUATOR - INSTALLATION, OPERATION & MAINTENANCE MANUAL**
**STANDARD ROTATION:**

Air to port A forces the pistons outwards, causing the springs to compress, the pinion turns counterclockwise while air is being exhausted from port B. Loss of air pressure on port A, the stored energy in the springs forces the pistons inwards. The pinion turns clockwise while air is being exhausted from port A.

**REVERSE ROTATION:**

Air to port A forces the pistons outwards, causing the springs to compress, the pinion turns clockwise while air is being exhausted from port B. Loss of air pressure on port A, the stored energy in the springs forces the pistons inwards. The pinion turns counterclockwise while air is being exhausted from port A.

**ASSEMBLY TO VALVE:**

Pneumatic actuators are fitted with a double square "star" pattern drive shaft and a mounting bolt pattern conforming to ISO Standards. This allows the actuator to be fitted to valves in increments of 90°, allowing mounting alignment either inline or across the line of the pipe work, enabling the most efficient use of space without the position affecting the actuators basic operation.

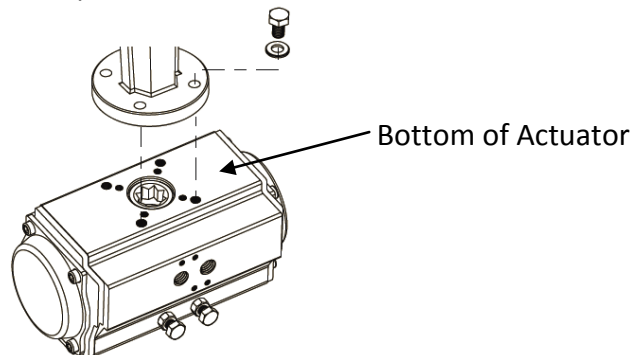

1. Fit the square of the valve directly into the square of the actuator.
  - a. At times an insert will need to be used.
2. Bolt together through the valve ISO pad.

Following should be noted prior to assembly to valves:

- Determine the desired operation of the assembly, Normally closed valve (NC), or Normally open (NO).
- Check that valve and actuator are in the same position (open or closed).
- Check the correct positioning (alignment) of all the elements of the group, valve, coupler, bracket and actuator.
- Use the cross pattern method to ensure an even clamping load.
- Ensure all position indicators are correctly adjusted and show the correct position.

**IMPORTANT: When using a spring return actuator for a fail safe operation, ensure that, when air or electricity failure occurs, the direction of rotation is correct for your application.**

## aero<sup>2</sup> ACTUATOR - INSTALLATION, OPERATION & MAINTENANCE MANUAL

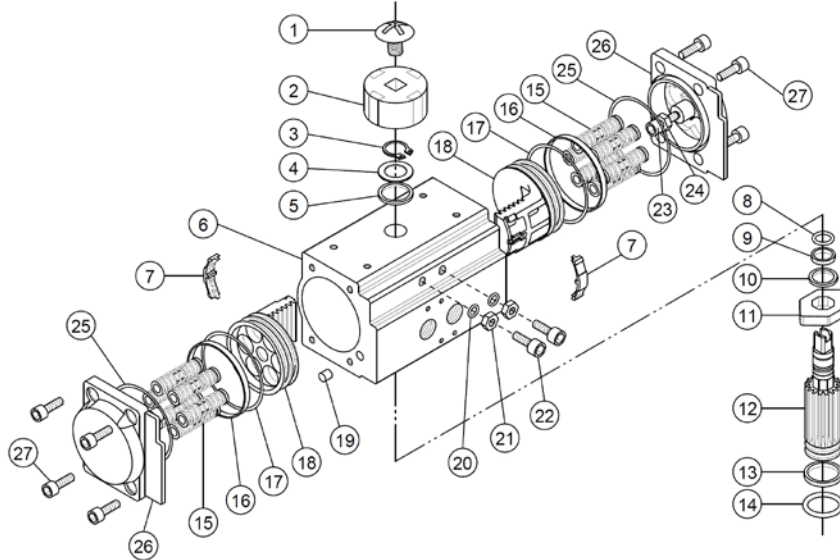

### MATERIALS OF CONSTRUCTION

ITEM	DESCRIPTION	MATERIALS SPECIFICATIONS
1	Indicator Cap Screw	Plastic/Stainless Steel
2	Position Indicator	Plastic (ABS)
3	Pinion Snap Ring	Stainless Steel 300 Series
4	Thrust Washer	Stainless Steel 300 Series
5	Thrust Bearing	Polyoxymethylene (Delrin®)
6	Body	Extruded Aluminum Alloy
7	Piston Guide	Polyoxymethylene (Delrin®)
8	O-Ring (Pinion Top)	Buna "N" (standard), Viton®
9	Bearing (Pinion Top)	Polyoxymethylene (Delrin®)
10	Inside Washer	Polyoxymethylene (Delrin®)
11	Stroke Adjustment Stop	Alloy Steel
12	Pinion (Drive Shaft)	Nickel Plated Alloy Steel
13	Bearing (Pinion Bottom)	Polyoxymethylene (Delrin®)
14	O-Ring (Pinion Bottom)	Buna "N" (standard), Viton®
15	Spring (Cartridge)	Spring Steel (Corrosion Resistant)
16	Bearing (Piston)	Polyoxymethylene (Delrin®)
17	O-Ring (Piston)	Buna "N" (standard), Viton®
18	Piston	Aluminum
19	Plug	NBR
20	O-Ring (Adjust Screw)	Buna "N" (standard), Viton®
21	Stop Nut (Adjust Screw)	Stainless Steel 300 Series
22	Adjust Screw	Stainless Steel 300 Series
23	Stop Screw	Stainless Steel 300 Series
24	Nut (Stop Screw)	Stainless Steel 300 Series
25	O-Ring (End Cap)	Buna "N" (standard), Viton®
26	End Cap	Aluminum
27	End Cap Screw	Stainless Steel 300 Series

See Page 8 for aero2 Repair Kits

**aero<sup>2</sup> ACTUATOR - INSTALLATION, OPERATION & MAINTENANCE MANUAL****DISASSEMBLY OF THE ACTUATOR**

1. Safely disconnect all electric power and supply lines connected to the actuator and or accessories.
2. Disassemble all the accessories of the actuator (solenoid, limit switch box, extra.)
3. Disassemble the actuator off the valve.
4. Remove indicator screw (#1), Lift position indicator (#2) off shaft, it may be necessary to pry gently with a screwdriver.
5. Unscrew the end caps screw (#27).

**Caution: When the actuator is a spring return unit, make sure that the actuator is in the failed position before disassembling.**

6. Remove stroke adjustment screw (#22) together with stop nut (#21) and O-rings (#20).
7. Remove the end caps (#26).
8. To rotate the pinion (#12) counterclockwise so that the pistons (#18) will exit the body (#6).

**Caution: Air pressure should not be used to remove the pistons from body.**

9. Remove the pinion snap ring (#3) and the thrust washers (#4) and thrust bearings (#5).
10. Remove the pinion (#12) stroke adjustment stop (#11) and inside washer (#10) from the body of the actuator, with downward force to the top of pinion.
11. Clean the components of the actuator perfectly.

**INSPECTION AND MAINTENANCE**

12. Inspect the components of the actuator for wear or damage and replace where necessary
13. Replace:
  - On the pinion: Pinion Snap Ring (#3) , O-ring (#8) and (#14) , washer (#5), Pinion bearing (#9) and (#13)
  - On the end caps : End cap O-ring (#25)
  - On the pistons : O-ring (#17) Piston guides (#7) Bearing (#16)

All springs where fitted should be replaced during periodic maintenance.

**RECOMMENDED REPLACEMENT PARTS (See Page 8 for aero2 Repair Kits)**

- PINION SNAP RING (#3)
- THRUST BEARING (#5)
- PISTON GUIDE (#7)
- PINION TOP O-RING (#8)
- PINION BEARING (#9)
- PINION BOTTOM BEARING (#13)
- PINION BOTTOM O-RING (#14)
- SPRING CARTRIDGE (#15)
- PISTON BEARING (#16)
- PISTON O-RING (#17)
- STROKE ADJUSTMENT SCREW O-RINGS (#20)
- END CAP O-RING (#25)



## aero<sup>2</sup> ACTUATOR - INSTALLATION, OPERATION & MAINTENANCE MANUAL

### ASSEMBLY OF THE ACTUATOR

VERY IMPORTANT before beginning the assembly check always that all the O-rings and gaskets that are compatible with Buna and Viton rubbers are in their proper position, and all the components are greased correctly using a standard commercial grease.

1. Refit the pinion (#12) in the body of the actuator (#6) ensuring the stroke adjustment stop (#11) is correctly fit during assembly. Ensure the pinion will rotate in counter-clockwise & clockwise when the stroke adjustment screws (#22) are refitted.
2. Fit washers (#5), (#4) and pinion snap ring (#3) to the top of pinion.
3. Refit the pistons (#18) in the body (#6) keeping in mind that both pistons should engage the gear of the pinion (#12) at the same time.
  - a. For reverse rotation of the actuator refer to page 7.
4. For standard rotation assembly, rotating the pinion (#12) about 40° ~50° in a clockwise direction until the pistons are correctly retracted. Check that the pinion output end is square to the body and is in the correctly aligned.

**Note:** Obtaining the correct gear tooth and piston alignment could require more than one attempt.

5. Mount the end cap (#26) to the body and tighten the screws (#27) distributing the force evenly until the end cap is securely home. Caution should be taken not to "pinch" the o-rings during this assembly procedure. In spring return actuators, it will be necessary to insert the spring cartridges appropriately in their correct location in the end caps according to the quantity of the springs you use (see detail).

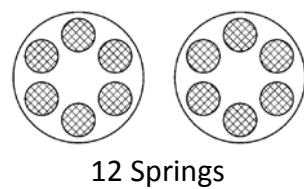
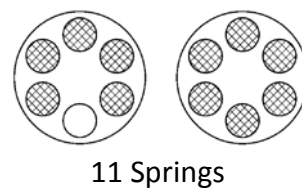
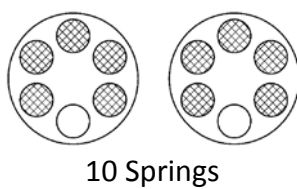
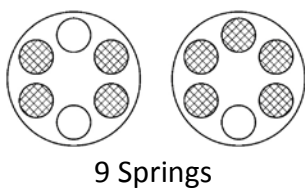
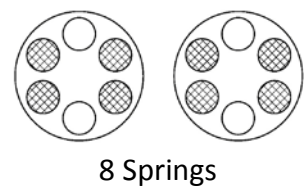
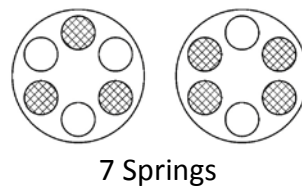
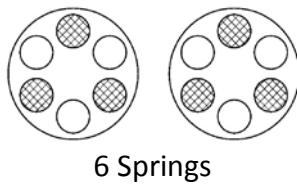
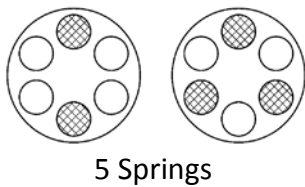

6. Fit the stroke adjustment screw (#22) with the nut (#21) and o-ring (#20) in the body.



aero<sup>2</sup> ACTUATOR - INSTALLATION, OPERATION & MAINTENANCE MANUAL

Reverse Rotation on *aero<sup>2</sup>* Actuators

1

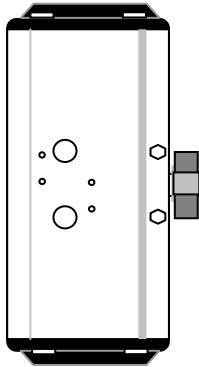

Remove End Caps

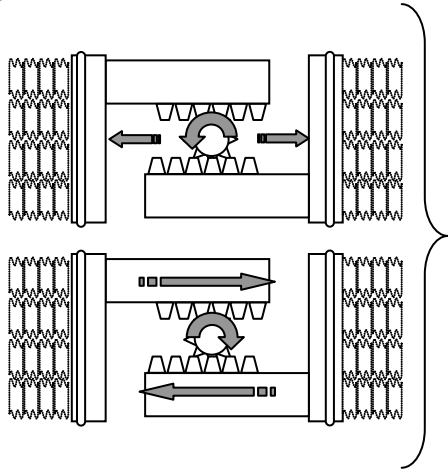

Standard Configuration

- 1- Air Stroke pushes pistons outward which are engaged with the pinion gear (output shaft) to rotate CCW – OPEN
- 2- Spring Stroke pushes pistons inward which are engaged with the pinion gear (output shaft) to rotate CW – CLOSED

2

Remove Indicator Cap and use the wrench flats to assist with removal and replacement of pistons

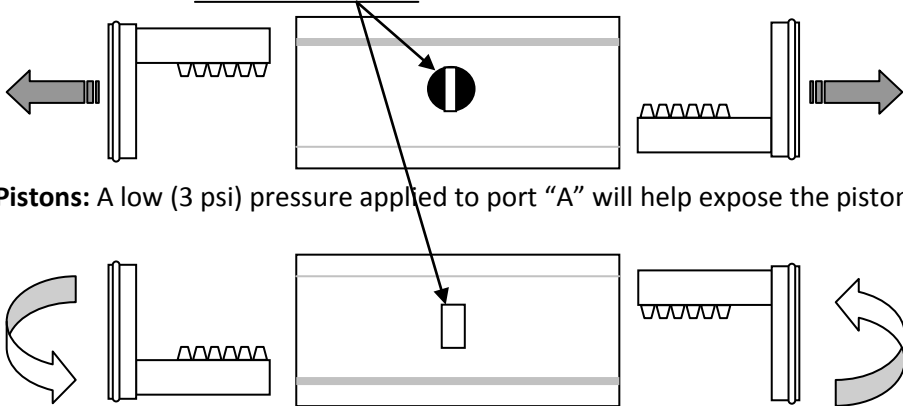

Remove Pistons: A low (3 psi) pressure applied to port "A" will help expose the pistons for removal.

Rotate pistons and re-insert. Note: Before engaging the piston (gear rack) with the pinion, "Back Rotate" the pinion gear by one tooth for proper orientation.

3

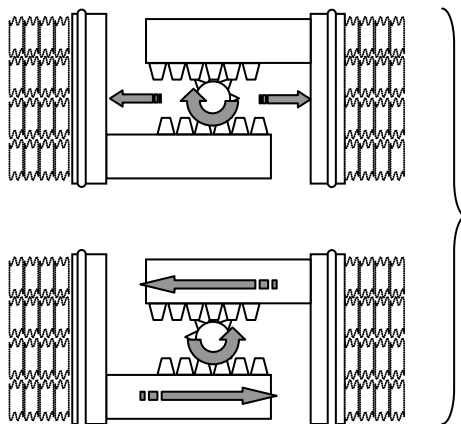

Reverse Configuration

- 1- Air Stroke pushes pistons outward which are engaged with the pinion gear (output shaft) to rotate CW – CLOSED
- 2- Spring Stroke pushes pistons inward which are engaged with the pinion gear (output shaft) to rotate CCW – OPEN

**aero<sup>2</sup> ACTUATOR - INSTALLATION, OPERATION & MAINTENANCE MANUAL**

**ENDSTOP ADJUSTMENT - CLOCKWISE:**

**(Right Adjusting screw)**

- Loosen the security nut (#21) of the right hand external stroke adjustment screw.
- Tighten or loosen the external stroke adjustment screw (#22) until reaching the required position.
- Tighten the security nut (#21) of the right hand external stroke adjustment screw.

**ENDSTOP ADJUSTMENT - COUNTERCLOCKWISE:**

**(Left Adjusting screw)**

- Loosen the security nut (#21) of the left hand external stroke adjustment screw
- Tighten or loosen the external stroke adjustment screw (#22) until reaching the required position.
- Tighten the security nut (#21) of the left hand external stroke adjustment screw.

**PRESSURE TEST:**

Pressure test the actuator with 90 psig (6 bar) compressed air and inspect for leaks using a soap and water solution sprayed on to all joints and rotating shafts.

**STORAGE:**

To store the pneumatic actuators the following precautions are recommended:

- Ensure the actuator is completely dry and water free.
- Maintain the entrances of air passages by fitting the original or replacement plastic corks.
- Protect from dust, dirt and damage by packing in box or plastic bag.

**ALL PNEUMATIC ACTUATORS HAVE BEEN 100% FACTORY TESTED IN OPERATION & WATERTIGHTNESS AND HAVE BEEN FITTED WITH INDIVIDUAL QUALITY CONTROL STAMPS.**

aero2 Repair Kit Components		
	ITEM	QTY
When ordering a Repair Kit for an aero2 Actuator, specify The Actuator Model Number.	Pinion Snap Ring	1
	Thrust Washer	1
	Thrust Bearing	1
	Piston Guide	2
	O-Ring (Pinion Top)	1
	Bearing (Pinion Bottom)	1
	Inside Washer	1
	Bearing (Pinion Bottom)	1
	O-Ring (Pinion Bottom)	1
	Bearing (Piston)	2
	O-Ring (Piston)	2
	Plug	2
	O-Ring (Adjust Screw)	2
O-Ring (End Cap)	2	